

*Monolito Forum* is an urban element that was first designed for the purpose of simply guiding pedestrians and without competing formally with its surroundings. It is made up of a square concrete base with a slot in one side for housing an oven-baked painted steel plate upon which a sign can be placed. Apart from its function as a marker and information element, it offers visitors a place in which to meet and rest.

Concrete | 📏 90 cm | ⚖️ 960 kg

🔄 Update 10.10.2018



#### Origen

The *Monolitos Forum* were installed on the huge esplanade of the Fórum Park in Barcelona, and designed specifically to provide information about the Fórum and its events and routes.

#### Design

Designed for ease of transportation by a pallet machine, it is self-balancing due to its weight and complies with the European guidelines on wind resistance in any site where it is exposed to wind. Its design includes adaptation to sloping terrain by means of adjustable height supports.

#### Material

Made from non-reinforced moulded concrete with an etched and water-repellent, granite grey finish. Chrome-plated sheet metal panel painted in the RAL chart colours. Adjustable feet with a threaded galvanised steel rod and black EPDM elastomer support.

#### Installation

It is self-balancing and is installed directly on the ground, with no need for anchoring elements.





# 1. Signaling limit

## Monolito Forum

**Dimensions** 90 x 90 x 45 (295) cm

**Weight** 960 kg

### 1.1 General features

<b>Base</b>	Concrete	<b>Fixing</b>	Free-standing
<b>Finish</b>	Etched and waterproofed		
<b>Panel</b>	Metal sheet	<b>Finish</b>	Zinc-plated and painted RAL colour chart

### Colores



**GR.** Grey

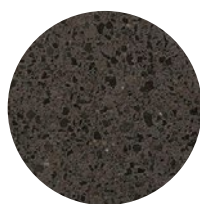

**NG.** Black

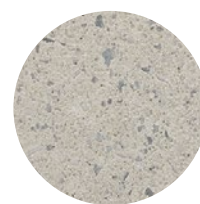

**BL.** White



**CA.** CA Grey

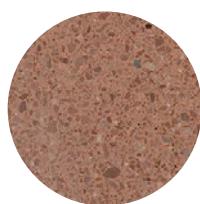

**RA.** Red

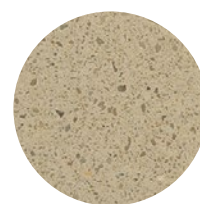

**BG.** Beige

### 1.2 Installation system

**Hoisting**  
(W= 960 kg)

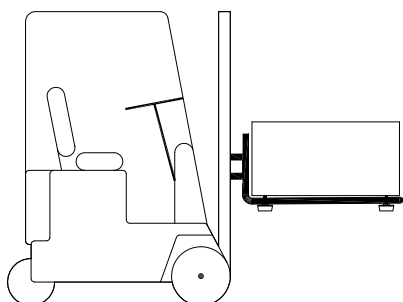

## 1.3 Geometry

### Base

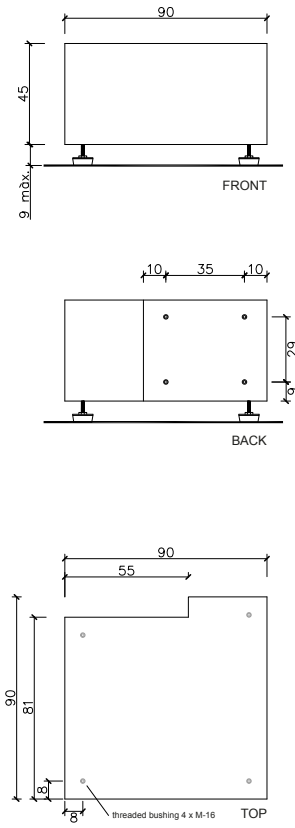

### Panel

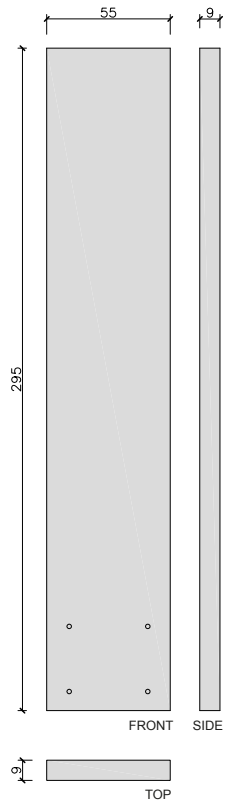

### Monolito

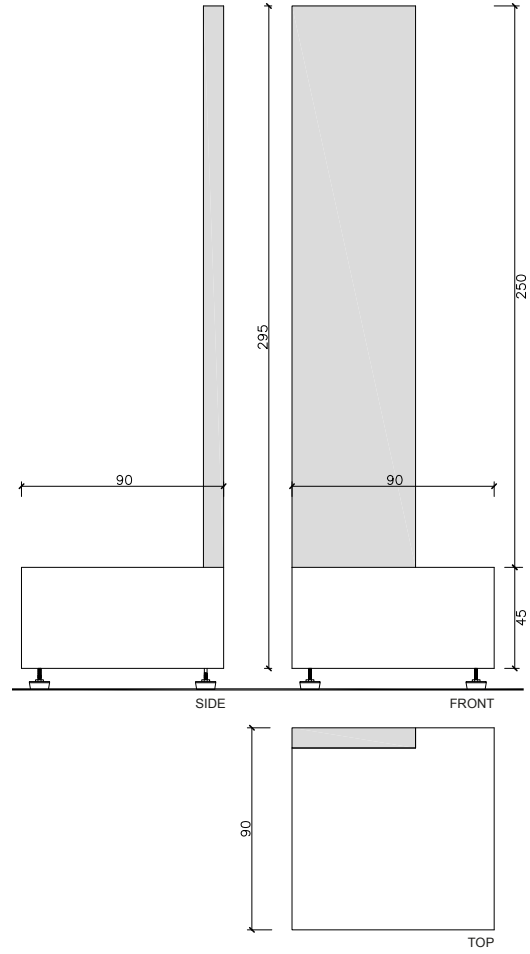

### Aggregations

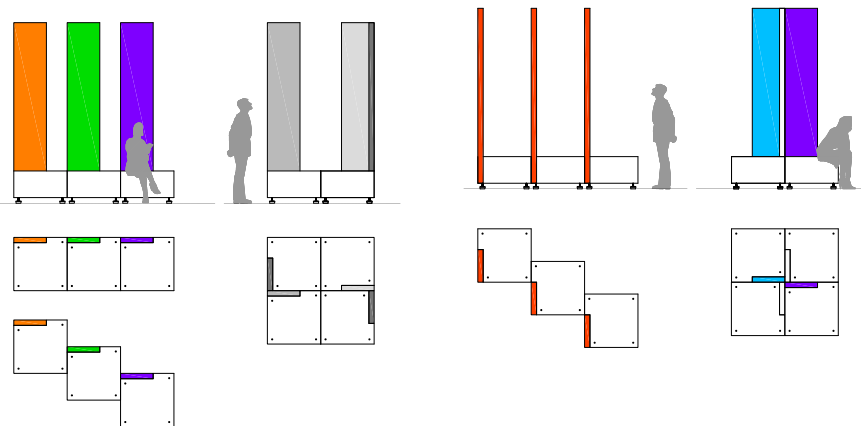



## Warranty

5 years in concrete elements.

The names, trademarks and industrial models of the products have been logged in the corresponding registers. The technical information provided by Escofet about its products can be modified without prior notice.

Escofet 1886 S.A  
Head office and production

Montserrat, 162  
E 08760 Martorell  
Barcelona - España  
T. 0034 937 737 150  
F. 0034 937 737 151

info@escofet.com  
www.escofet.com

Follow us



GA-2005/0072 SST-0090/2010 ER-0403/2016