

CARACTERÍSTICAS

FUSTE Acero al carbono S275JR galvanizado.
Color negro, efecto forja.

LUMINARIA Aluminio extruido 6063 T5.
Color negro, efecto forja.
Grado de protección IP66 (Componentes).
Cierre mediante cerradura de tracción.

PESO Luminaria 11kg. / Columna (7m) 148 kg.

POLE S275JR carbon steel tube, hot dip galvanized.
Colour black forge.

LIGHTING Extruded 6063 T5 aluminium tube.
Colour black forge.
IP66 protection degree (Components).
Closing with O-ring seal.

WEIGHT Lighting 11kg. / Pole (7m) 148 kg.

DISEÑO / DESIGN Jord Miralles, Jordi Miró
Antoni Riera

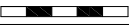
E: 0  100 CM



BALI - 7 / 5

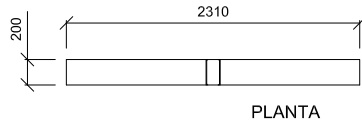

BALI - 6D

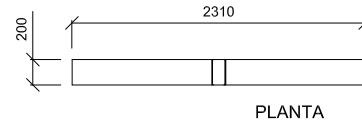

BALI - 4S

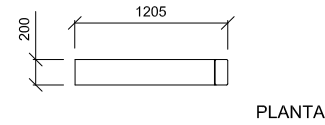

BALI APLIQUE

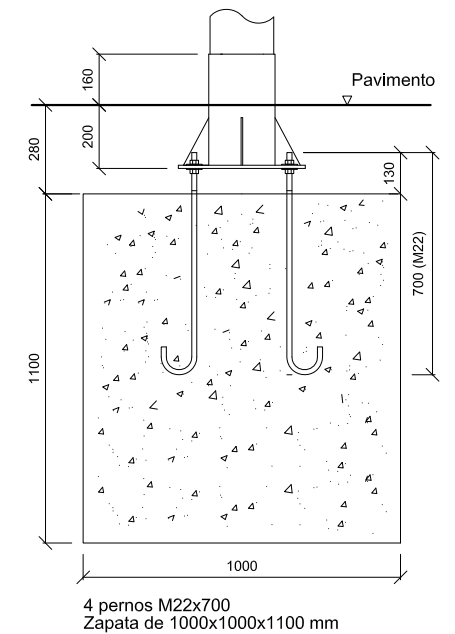
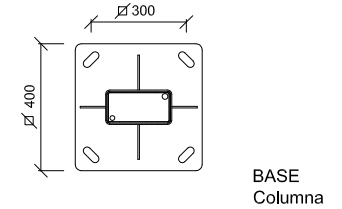
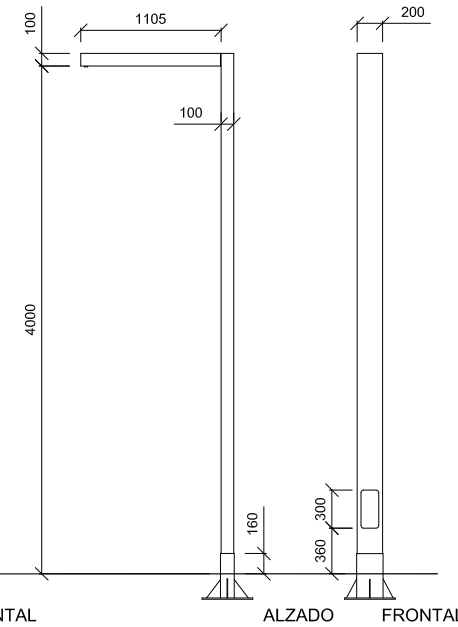
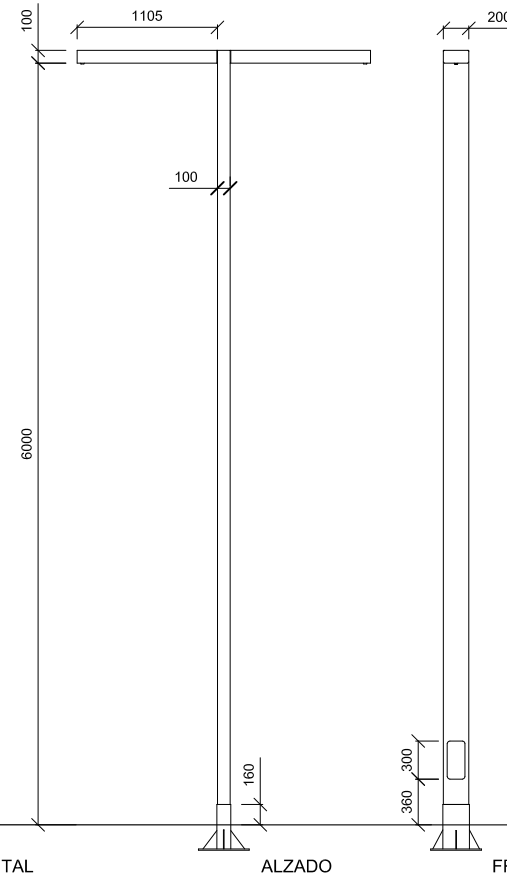
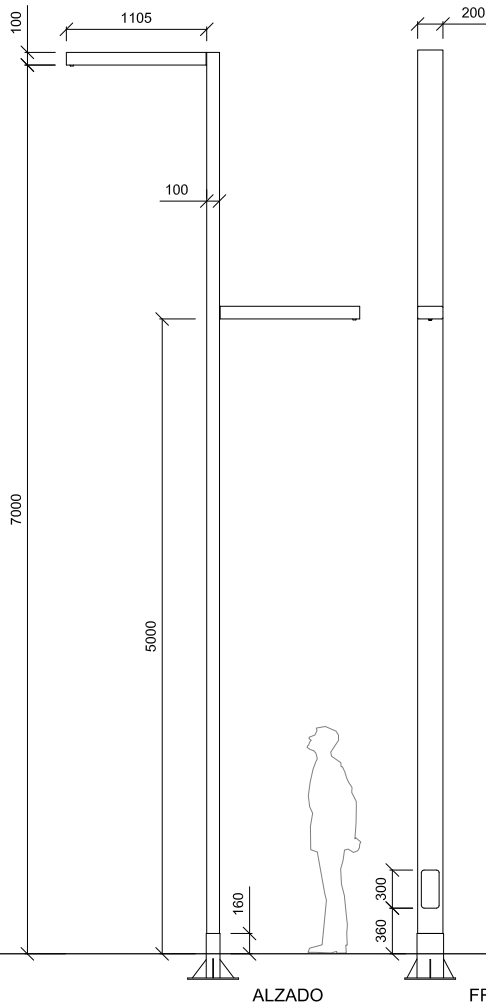
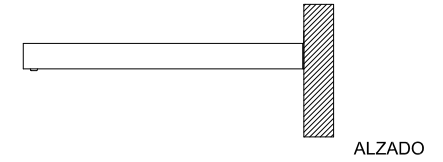

CARACTERÍSTICAS

GRUPO
ÓPTICO

(1) LED. Driver Vossloh o similar. 120 - 277V AC. 50/60Hz.
Potencias 25W, 50W, 75W o 100W
Rendimiento 106lm/W. / Io=700mA. / IEE: A+
Factor de potencia 0,95(min). / Temp. color 3000K o 4000K / CRI>70
Driver preparado para regulación (1-10V)
(2) HM. CPO-TW. Base PGZ12. Potencias 45W, 60W, 90W o 140W
Balastro electrónico preparado para regulación
Micro-reflector asimétrico de aluminio

GROUP
OPTIC

(1) LED. Driver Vossloh or similar. 120 - 277V AC. 50/60Hz.
Power input 25W, 50W, 75W or 100W
Energy efficiency 106lm/W. Io=700mA. / IEE: A+
Power factor 0,95(min). / Temperature 3000K or 4000K / CRI>70
Lighting control driver (1-10V)
(2) HM. CPO-TW. Base PGZ12. Power input 45W, 60W, 90W or 140W
Electronic ballast dimmer
Aluminium asymmetric micro-reflector



BALI LED

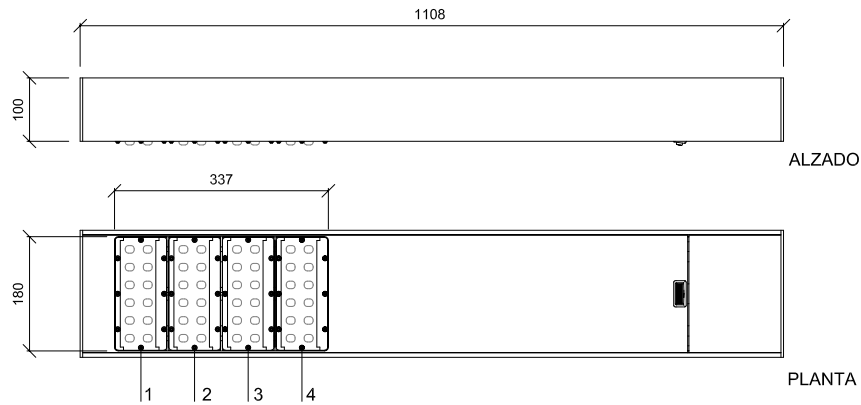

ALZADO

PLANTA

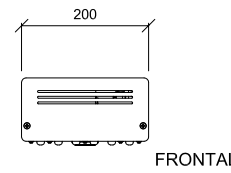

FRONTAL

Distribución módulo LED
LED Module distribution

- 25W (1)
- 50W (1 + 2)
- 75W (1 + 2 + 3)
- 100W (1 + 2 + 3 + 4)

Curva de distribución de la intensidad lumínica
Typical light distribution curve

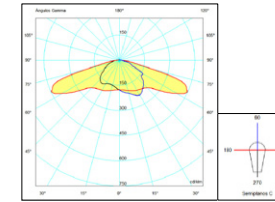

LED 3C

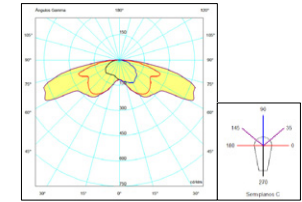

LED 4C

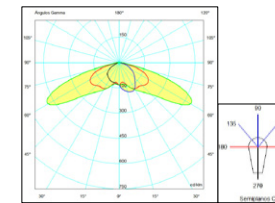

Microreflector 45W-60W

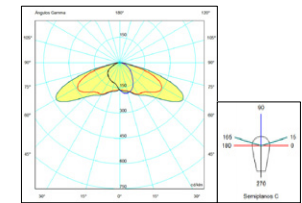

Microreflector 90W-140W

BALI HM

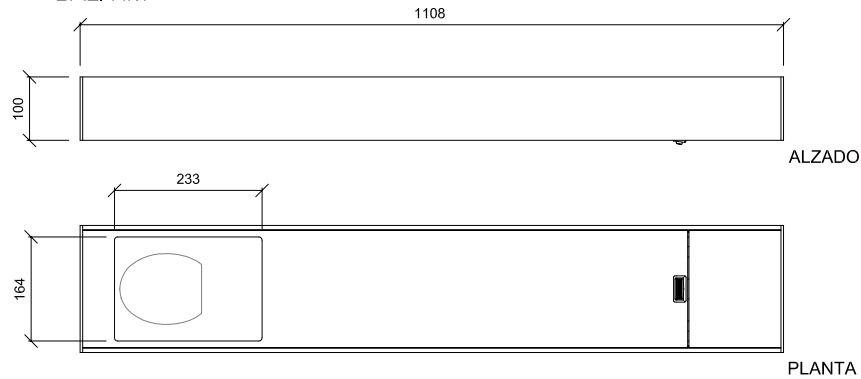

ALZADO

PLANTA

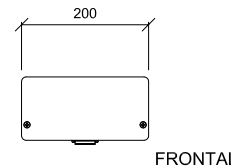

FRONTAL

